

USER GUIDE

Digital Satellite Receiver

**Models DSR207, DSR209, DSR317, DSR319,
DSR505, and DSR530**





CONTENTS

IMPORTANT SAFETY INSTRUCTIONS	1
DSR BASICS — SYMBOLS/ICONS	6
Front Panel	6
Back Panel	7
CONNECTING YOUR DSR	10



IMPORTANT SAFETY INSTRUCTIONS

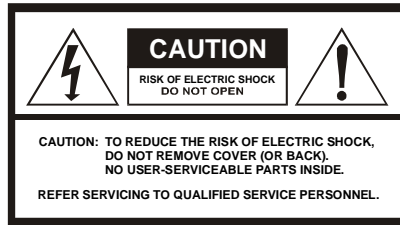

WARNING

TO REDUCE THE RISK OF FIRE OR ELECTRICAL SHOCK, DO NOT EXPOSE THIS APPLIANCE TO RAIN OR MOISTURE.

CAUTION

TO PREVENT ELECTRICAL SHOCK, MATCH THE BLADE OF THE PLUG TO THE WIDE SLOT AND FULLY INSERT IN RECEPTACLE.

Important Safety Instructions

- Read these instructions.
- Keep these instructions.
- Heed all warnings.
- Follow all instructions.
- Do not use this apparatus near water.
- Clean only with dry cloth.
- Do not block any ventilation openings. Install in accordance with the manufacturer's instructions.
- Do not install near any heat sources such as radiators, heat registers, stoves, or other apparatus (including amplifiers) that produce heat.
- Do not defeat the safety purpose of the polarized or grounding-type plug. A polarized plug has two blades with one wider than the other. A grounding-type plug has two blades and a third grounding prong. The wide blade or the third prong is provided for your safety. If the provided plug does

IMPORTANT SAFETY INSTRUCTIONS

not fit into your outlet, consult an electrician for replacement of the obsolete outlet.

- Protect the power cord from being walked on or pinched, particularly at plugs, convenience receptacles, and the point where they exit from the apparatus.
- Use only attachments and accessories specified by the manufacturer.
- Unplug this apparatus during lightning storms or when unused for long periods of time.
- Refer all servicing to qualified service personnel. Servicing is required when the apparatus has been damaged in any way, such as when the power-supply cord or plug is damaged, liquid has been spilled or objects have fallen into the apparatus, the apparatus has been exposed to rain or moisture, does not operate normally, or has been dropped.

WARNING — TO REDUCE THE RISK OF FIRE OR ELECTRIC SHOCK, DO NOT EXPOSE THIS APPLIANCE TO RAIN OR MOISTURE.

Repairs

If you find the unit in need of repair, contact Star Choice for repair or replacement.

Damage Requiring Service. Unplug this equipment from the power source, and contact a qualified service provider if any of the following situations occurs:

- If the power supply cord or plug is damaged.
- If liquid or objects have fallen into the unit.
- If the unit became wet from rain or water.
- If the unit was dropped or damaged.
- If the unit's performance changes.

Service. Do not try to service this product yourself. If you open or remove the cover, you may be exposed to dangerous voltage or other hazards and may void the unit's warranty. Contact a qualified service provider for all service.

IMPORTANT SAFETY INSTRUCTIONS

Replacement Parts. If replacement parts are required, be sure the service technician uses replacement parts specified by the manufacturer or have the same characteristics as the original part. Unauthorized substitution may result in risk of fire, electric shock, or other hazards.

Safety Check. After the unit is serviced or repaired, ask the service technician to perform safety checks to find out if the unit is in proper operating condition.

Accessory. DRS207 and DSR209 — For use with UL Listed Accessory Switching Power Supply Adapter model PB-1240-01A-ROHS.

Regulatory Information

Federal Communications Commission Radio and Television Interface Statement for a Class 'B' Device

This device complies with part 15 of the FCC Rules. Operation is subject to the following two conditions: (1) This device may not cause harmful interference, and (2) this device must accept any interference

received, including interference that may cause undesired operation.

This equipment has been tested and found to comply with the limits for a Class B digital device, pursuant to part 15 of the FCC Rules. These limits are designed to provide reasonable protection against harmful interference in the residential installation. This equipment generates, uses, and can radiate radio frequency energy and, if not installed and used in accordance with the instructions, may cause harmful interference to radio communications. However, there is no guarantee that interference will not occur in a particular installation.

If the equipment does cause harmful interference to radio or television reception, which can be determined by turning the equipment off and on, the user is encouraged to try to correct the interference by one of the following measures:

- Increase the separation between the equipment and the affected receiver.

IMPORTANT SAFETY INSTRUCTIONS

- Connect the equipment into an outlet on a circuit different from the one the receiver is on.

Consult the dealer or an experienced radio/TV technician for help.

Changes or modification not expressly approved by the party responsible for compliance could void the user's authority to operate the equipment.

Declaration of Conformity

According to 47 CFR, Parts 2 and 15 for Class B Personal Computers and Peripherals, and/or CPU Boards and Power Supplies used with Class B Personal Computers, Motorola, Inc., 101 Tournament Drive, Horsham PA, 1-215-323-1000, declares under sole responsibility that the product complies with 47 CFR Parts 2 and 15 of the FCC Rules as a Class B digital device. Each product marketed is identical to the representative unit tested and found to be compliant with the standards. Records maintained continue to reflect the equipment being produced and can be expected to be within the variation accepted, due to quantity production and testing on a statistical

basis as required by 47 CFR 2.909. Operation is subject to the following condition: This device must accept any interference received, including interference that may cause undesired operation. The above-named party is responsible for ensuring that the equipment complies with the standards of 47 CFR, Paragraphs 15.107 to 15.109.

Canadian Compliance

This Class B digital device complies with Canadian ICES-003.

IMPORTANT SAFETY INSTRUCTIONS





© 2008 Motorola, Inc. All rights reserved. No part of this publication may be reproduced in any form or by any means or used to make any derivative work (such as translation, transformation, or adaptation) without written permission from Motorola, Inc.

MOTOROLA and the Stylized M logo are registered in the US Patent and Trademark Office. All other product or service names are the property of their respective owners.







Motorola reserves the right to revise this publication and to make changes in content from time to time without obligation on the part of Motorola to provide notification of such revision or change. Motorola provides this guide without warranty of any kind, implied or expressed, including, but not limited to, the implied warranties of merchantability and fitness for a particular purpose. Motorola may make improvements or changes in the product(s) described in this manual at any time







DSR BASICS — SYMBOLS/ICONS

Front Panel		207	209	317	319	505	530
	ON/STANDBY.	√	√	√	√	√	√
	GO BACK To return to a previous menu or the last channel viewed.			√	√	√	√
	OPTIONS To display the Main Menu.			√	√	√	√
	NAVIGATION To navigate within menus or change channels up and down.			√	√	√	√
	SELECT To select a highlighted menu option.			√	√	√	√



DSR BASICS — SYMBOLS/ICONS

Back Panel		207	209	317	319	505	530
	Back panel POWER cord connection.	√	√	√	√	√	√
	TELEPHONE LINE For Instant Pay-Per-View (IPPV) reportback and caller ID.			√	√	√	√
	ANTENNA INPUT For analog off-air broadcast antenna or Cable TV.			√	√	√	√
	DIGITAL VIDEO INTERFACE (DVI).					√	√
	CH3/4 SWITCH To set the RF output to channel 3 or 4.	√	√	√	√	√	√
	RF OUTPUT Modulated Channel 3/4 Output or Off-air Broadcast/Cable Pass-through Output	√	√	√	√	√	√

DSR BASICS — SYMBOLS/ICONS

Back Panel		207	209	317	319	505	530
	USB PORTS (for future use)	1	1	1	1	1	2
	COMPOSITE VIDEO OUTPUTS	1	1	2	2	2	2
Y Pb Pr	COMPONENT VIDEO OUTPUT					√	√
	STEREO AUDIO OUTPUTS	1	1	2	2	2	2
	OPTICAL DIGITAL AUDIO OUTPUT			√	√	√	√
	S-VIDEO OUTPUT			√	√	√	√

DSR BASICS — SYMBOLS/ICONS

Back Panel		207	209	317	319	505	530
	UHF REMOTE CONTROL ANTENNA PORT					√	√
	DIGITAL AUDIO OUTPUT (RCA/coax — electrical)			√	√	√	√
	SATELLITE INPUT	1	1	1	1	1	2**
<p>**Note: The DSR530 is equipped with two satellite tuners. Each requires a separate satellite input connection to be able to watch one program while recording another program.</p>							



CONNECTING YOUR DSR

Make sure that the satellite receiver is not plugged into a power source before you connect any cables to the receiver. First connect the satellite input from your satellite dish to your receiver.

There are several options to connect your DSR, and not every DSR model, TV, or other component includes all of the connection types described below. Review the appropriate manuals if necessary to determine the best connection for your system.

Video: Use Composite video output (better), S-Video output (best for standard definition), Component video, or DVI outputs (best for high definition) to connect the DSR directly to your television, VCR, and home theater A/V receiver.

Channel 3/4 RF modulator output to TV: If your TV is equipped with only one signal input connection (usually labeled Antenna/CATV input), connect the DSR's modulated RF output to TV input to receive picture and sound with your TV tuned to either channel 3 or 4, depending on the channel 3/4 slide switch setting on the back of your DSR.

Audio: The modulated RF output also provides audio along with video to televisions or VCRs (good). Utilize the stereo audio output (better) or the coaxial or optical Digital audio outputs (best) to connect the DSR directly to your television, VCR, and home theater A/V receiver.

CONNECTING YOUR DSR

Modem: Connect the telephone jack to a home telephone jack for Instant Pay-Per-View (IPPV) reportback and Caller ID. Star Choice will not permit IPPV unless this remains connected.

Ant In: If applicable, connect the external antenna input for local off-air or cable TV broadcast. The DSR will pass-through this RF source to the RF Output Connection when the DSR is in standby mode.

Once the above connections are secure, plug the DSR power cord or separate power supply (in the case of the DSR207 or DSR209) into a standard power outlet. Wait one minute, and then press the ON button located on the satellite receiver's front panel.

Notes:

Video and audio quality should be best when you connect the DSR directly to your TV/monitor/projector and an optional audio system. Use quality cables designed for these applications. Home theater A/V receivers can provide a method to connect multiple input sources if your TV does not have enough input connectors, and some home theater A/V receivers may enhance the video resolution or quality. Refer to your home theater A/V receiver instructions for further information.

If you are using the component or DVI video outputs, you may have to toggle the HDTV mode select button behind the flip-down door on the front panel of a DSR5xx series product. This toggles the HDTV output between 1080i, 720p, 480p, 480i, and native modes. Native mode (0000) is the original transmitted signal from the network/broadcaster. You should leave this on native mode unless your TV or monitor requires a specific mode, such as 1080i.

CONNECTING YOUR DSR

DSR207 and DSR209



Important Note: Not all connections are required. Review your television or home theatre manual for the best connections for your system.

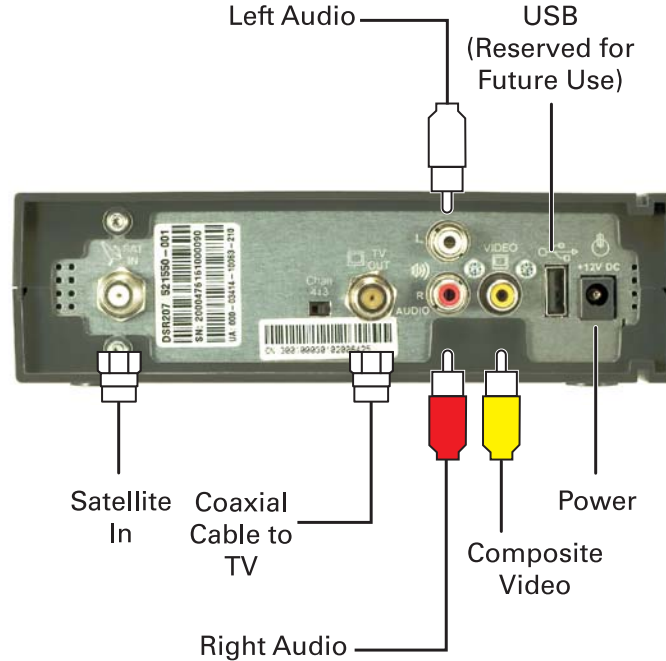

DSR317 and DSR319



Important Note: Not all connections are required. Review your television or home theatre manual for the best connections for your system.

CONNECTING YOUR DSR

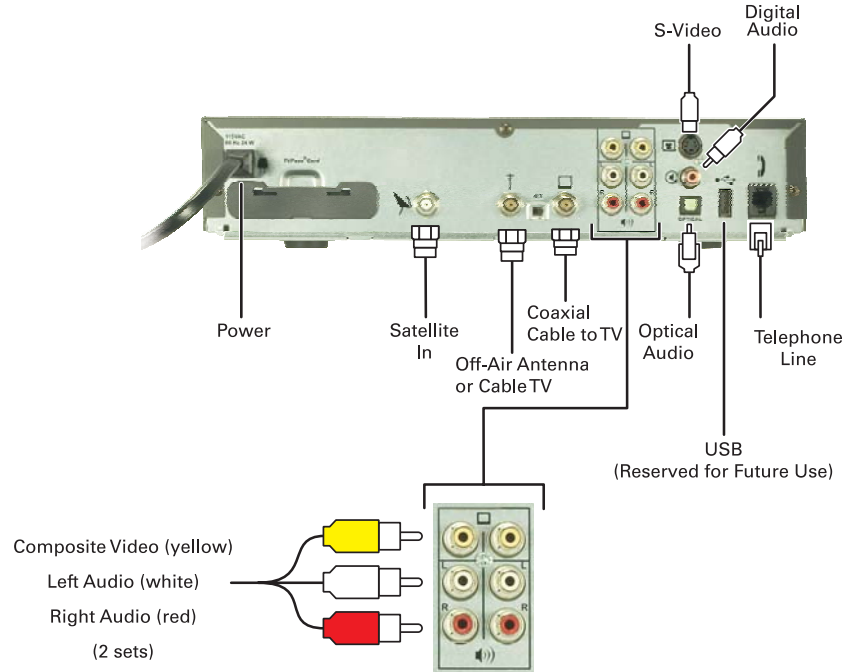

CONNECTING YOUR DSR

DSR505



Important Note: Not all connections are required. Review your television or home theatre manual for the best connections for your system.

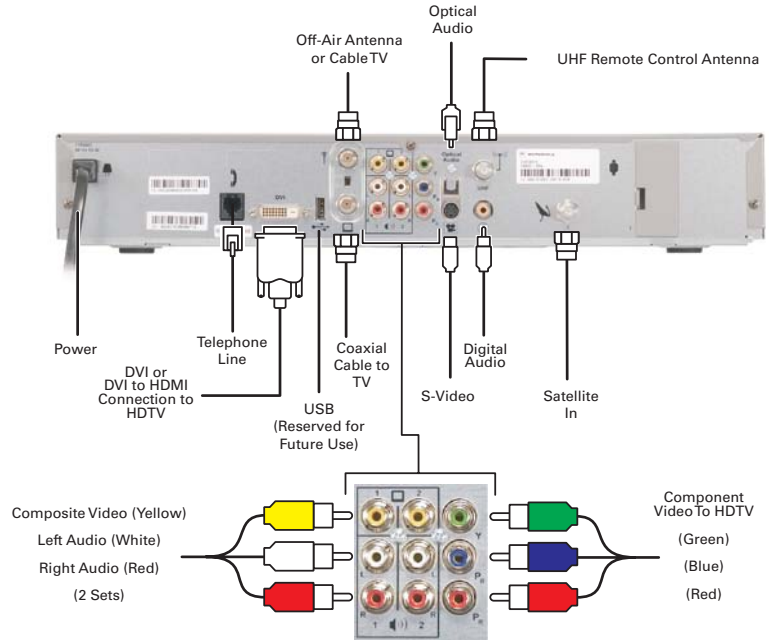

CONNECTING YOUR DSR

DSR530



MPEG4 Expansion Slot

Important Note: Not all connections are required. Review your television or home theatre manual for the best connections for your system.

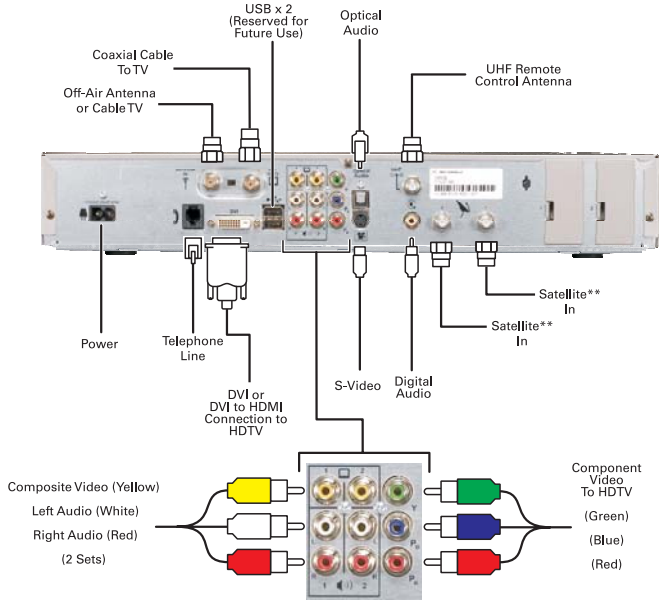

****Important Note:** The DSR530 is equipped with two satellite tuners. Each requires a separate satellite input connection to be able to watch one program while recording another program.



MOTOROLA

Motorola, Inc.
101 Tournament Drive
Horsham, PA 19044 U.S.A.

<http://www.motorola.com>

534019-001-e
05/08



Star Choice Communications Inc.
2924 – 11 Street NE
Calgary, AB T2E 7L7

<http://www.starchoice.com>